

Uniform transverse beam profile with a new type of nonlinear magnet^{*}

Sheng-Dong Gu(谷胜栋)¹⁾ Wei-Bin Liu(刘渭滨)

Key Laboratory of Particle Acceleration Physics and Technology, Institute of High Energy Physics, Chinese Academy of Sciences, 19(B) Yuquan Road, Beijing 100049, China

Abstract: In this paper, a new type of magnet is proposed and produced to give a uniform transverse beam profile. Compared to octupole magnets, the new type of magnet can provide a similar octupole magnet field in the middle, but the rise rate declines quickly at the edges, so that a beam of the same uniformity is obtained with less particle loss. Besides that, a mechanical structure is added to adjust the width of the middle region to satisfy different transverse dimensions, which would further reduce particle loss. Some numerical simulations have been done with the octupole and the new type of magnet to show the advantages of the new magnet.

Keywords: uniform beam, nonlinear magnet, beam dynamics, simulation, octupole

PACS: 29.20 **DOI:** 10.1088/1674-1137/41/6/067003

1 Introduction

Beams with uniform transverse distribution are required in various applications, such as irradiation of targets for isotope production, uniform irradiation of detectors for improved efficiency, and irradiation of biological samples and materials. Many methods have been proposed to get a uniform and well-confined beam. One method to get a uniform beam is using nonlinear optics. This method can get an ideal uniform beam, but it requires a combined magnet that is complicated to process. In practice, an octupole is usually used to replace the combined magnet, but this causes loss of particles in the halo. Many people have studied uniformization of transverse beam profiles with multipole magnets theoretically [1–4].

Yuri et al. have studied uniformization of a transverse beam profile using nonlinear magnets in detail. They got the relationship of the density distributions at the locations of the target and the multipole magnet as follows [1]:

$$\rho_t = \rho_0 \left(\frac{dx_t}{dx_0} \right)^{-1} = \frac{\rho_0}{M_{11} - \frac{\alpha_0}{\beta_0} M_{12} - M_{12} \sum_{n=3}^{\infty} \frac{K_{2n}}{(n-2)!} x_0^{n-2}} \quad (1)$$

where M is the transmission matrix, M_{ij} ($i, j = 1, 2$) are the elements of M , K_{2n} is the $2n$ -pole integrated strength of the multipole magnet, ρ_0 and ρ_t are initial and target particle density functions respectively, and β_0 and

β_t are initial and target beta functions respectively. According to this equation, the particle distribution can be transformed into a different one at the target by using nonlinear magnets.

Usually, the beam has a Gaussian or similar to Gaussian distribution. The required magnetic field can be found by replacing the initial density function ρ_0 with a Gaussian function and making a Taylor expansion. All odd-order nonlinear fields are required to transform an ideal Gaussian beam into a uniform beam. With only an octupole to provide the nonlinear field, the effect is not so good, and some particle loss will be caused.

2 A new type of magnet

In view of the effects and disadvantages of the octupole magnet, a new type of magnet has been designed and produced. The field of an octupole rises with an increasing rate along the axes while a quadrupole magnet field rises at a constant speed. If a shielding device is set in the middle of a quadrupole, the rise speed can be changed. With this idea, a new type of magnet is proposed. The field in the middle region of the new magnet is similar to an octupole magnetic field, but the rise rate declines quickly at the edge. With this feature, the beam can be transformed to uniform with less particle loss. Figure 1 shows a photograph and structural diagram of the new type of magnet. The magnet consists of four parts: two C-type dipoles, a shielding device, and a base. A lead screw is installed on the base to adjust the

Received 21 July 2016, Revised 4 February 2017

^{*} Supported supported by National Natural Science Foundation of China (11175195)

1) E-mail: gushengdong@ihep.ac.cn

©2017 Chinese Physical Society and the Institute of High Energy Physics of the Chinese Academy of Sciences and the Institute of Modern Physics of the Chinese Academy of Sciences and IOP Publishing Ltd

distance between the two C-type dipoles. The width of the octupole-like region can be regulated from 40 mm to 80 mm by turning the lead screw to adjust the distance of the two dipoles from 41 mm to 81 mm. We have produced a prototype of this magnet and measured the field. Figures 2 and 3 show comparisons between the measured results and simulation results at different distances between the two C-type dipoles. The solid lines show the simulation results while the points are measured values. Due to the unique characteristics of the magnet, the magnetic field was measured at many different points. The measured points in Figs. 2 and 3 are integral values of different points along the beam direction. The measured results agree with the simulation results at different distances. The results prove the feasibility of the new type of magnet. As discussed, to use the new magnet for uniformization, it must have an octupole-like field in the

middle. A comparison between the fields of an octupole and the new type of magnet is shown in Fig. 4. As mentioned, the width of the octupole-like region can be changed according to requirements. The fields of the new magnet at minimum and maximum distances are plotted in Fig. 4. The new magnet has a minimum octupole-like width at the minimum distance and vice versa. Comparing with the octupole, the new magnet has almost the same magnetic field in the octupole-like region, but the growth rate of the magnetic field decreases quickly outside the middle region, which is useful to limit particle loss. According to the theory of Yuri et al., beams can be transformed to be uniform with all odd-order nonlinear magnets. It is hard to make a magnet have all the odd-order components, but using a combination of octupole and dodecapole magnet can get a more uniform beam compared with only using the octupole. The field of the new type of magnet is also like a combination magnetic field of octupole and dipole magnet. The ratio of the octupole strength to the dodecapole strength is not strictly equal to the theory of Yuri et al., but it is helpful.

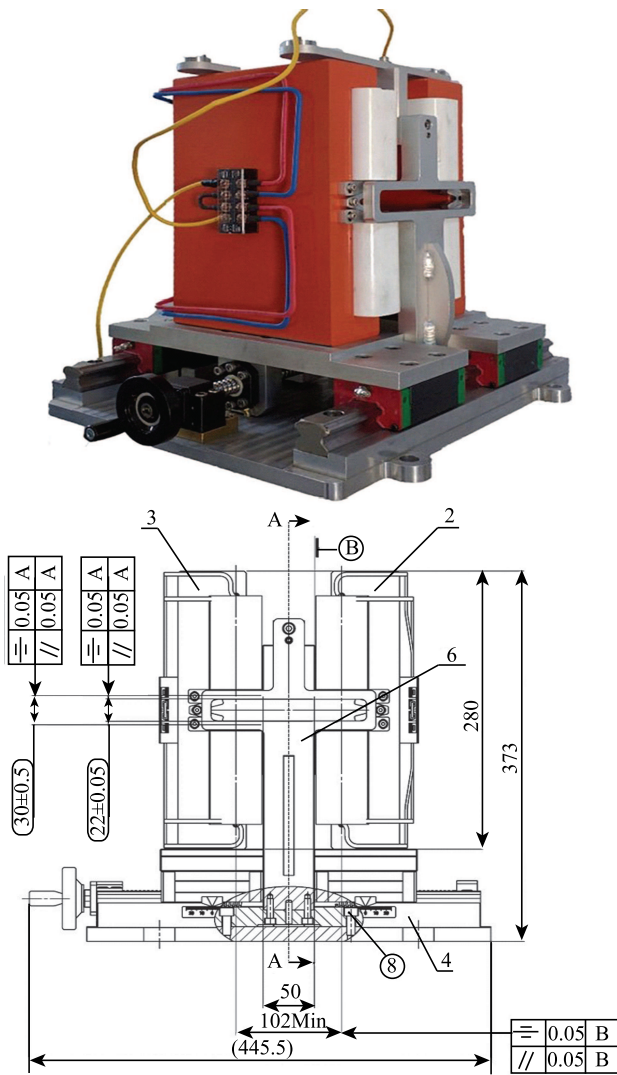

Fig. 1. (color online) Photograph and structure of the new type of magnet.

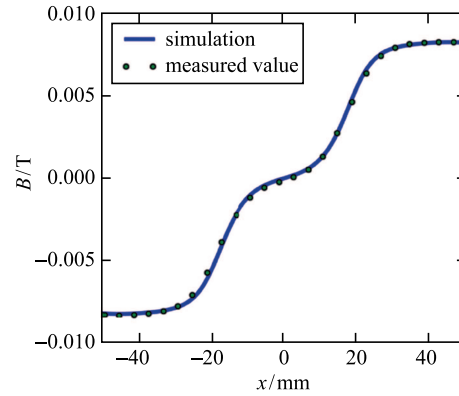

Fig. 2. (color online) Comparison between simulation results and measured results when the distance is 41 mm.

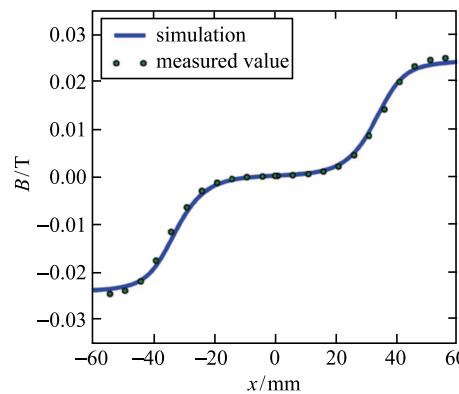

Fig. 3. (color online) Comparison between simulation results and measured results when the distance is 61 mm.

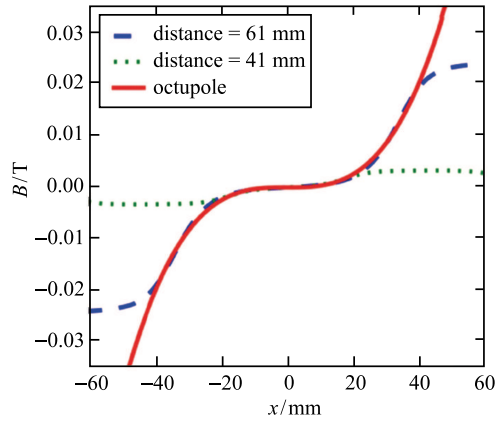

Fig. 4. (color online) Comparison between octupole magnet field and the new type of magnet.

3 Particle loss comparison between octupole and new magnet

In this part, particle loss during the uniform process will be discussed with a simple example as shown in Fig. 5. The beam passes a nonlinear magnet and some quadrupoles and finally reaches the target. The parameters are listed in Table 1. The nonlinear magnet will result in coupling between the horizontal and vertical components. In practice, a beam is usually operated to be flat when passing a nonlinear magnet to limit the effect to one direction. In the following, we just discuss the one-dimensional case. The basic principle to get a uniform beam is to distort the beam in phase space by changing the momentum with a nonlinear magnet. As shown in Fig. 5, when a particle passes an octupole with integral strength KL , the coordinate transformation relations are:

$$\begin{cases} x_1 = x_0 \\ x'_1 = x'_0 - \frac{KL}{6}x_0^3 \end{cases}, \quad (2)$$

where x_0, x'_0 and x_1, x'_1 are the coordinates before and after the octupole respectively. x' is the derivative rela-

tive to the position s . The change of the momentum is a cube function of x_0 .

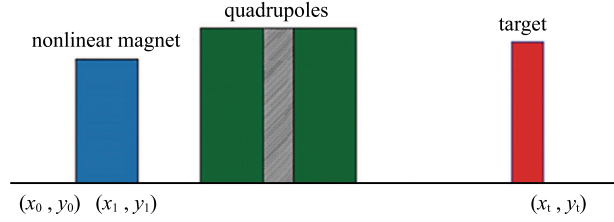

Fig. 5. (color online) A schematic plot of the transport system.

For a beam, as shown in Fig. 6, the beam is distorted with the effects of different nonlinear magnets. The two lines plotted in Fig. 6 represent distorted beam profiles with an octupole and with the new type of magnet respectively. The beam size of the profiles in Fig. 6 is up to quadruple δ , where δ is the root-mean-squared (RMS) radius. The beam profiles are quite different with different magnets. The Hamiltonian can be used to describe the differences. The particle Hamiltonian without and with the octupole can be written as:

$$H_0 = \gamma x_0^2 + 2\alpha x_0 x'_0 + \beta x_0'^2, \quad (3a)$$

$$H_1 = \gamma x_0^2 + 2\alpha x_0 \left(x'_0 - \frac{KL}{6}x_0^3 \right) + \beta \left(x'_0 - \frac{KL}{6}x_0^3 \right)^2. \quad (3b)$$

The Hamiltonian changes at different locations in the beam are listed in Table 2. The changes can be used to describe the beam distortions, which is useful to get a uniform beam on the target as discussed above. The Hamiltonian changes with the new type of magnet and the octupole are almost the same up to 20 mm, which is the width of the octupole-like region. 20 mm exceeds 2δ of this beam and about 95% of particles are located in the range of 2δ for a Gaussian beam. So the new magnet has the same effect in reaching uniform beam as the

Table 1. Beam parameters.

position	α	B/m	γ/m^{-1}	$\varepsilon/(mm \cdot mrad)$	Φ/rad
initial	53.2	28.5	40.8	3.08	0.07
final	3.6	45.4	0.3	3.08	

Table 2. Hamiltonians and coordinates with different magnets at different locations.

without nonlinear magnet		with octupole		with new type magnet	
$(x_0, x'_0)/(mm, mrad)$	$H_0/(m \cdot mrad)$	$(x_1, x'_1)/(mm, mrad)$	$H_1/(m \cdot mrad)$	$(x_1, x'_1)/(mm, mrad)$	$H_1/(m \cdot mrad)$
(10, -14)	157	(10, -15)	251	(10, -15)	247
(20, -29)	630	(20, -34)	2647	(20, -33)	2287
(30, -43)	1417	(30, -60)	1.6e4	(30, -54)	9.8e3
(40, -57)	2520	(40, -97)	6.8e4	(40, -75)	2.1e4

octupole. For the particles exceeding 2δ , the Hamiltonian changes are huge with an octupole compared with the new magnet. This means the amplitude of the β oscillation becomes much bigger for the octupole, and some particles are probably lost because of the limit of the beampipe. The phenomenon can be illustrated with the beam profiles on the target as shown in Fig. 7.

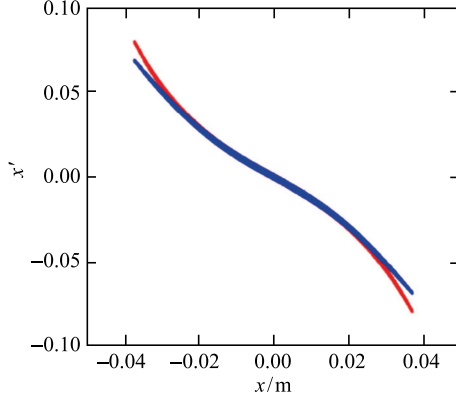

Fig. 6. (color online) The nonlinear magnet effect with an octupole (red) and with the new magnet (blue).

Figure 7 shows the beam profile on the target with an octupole and with the new type of magnet. With the beam distortion in phase space, the density distribution in real space is uniform now. Comparing the two pictures, the octupole gives a long “tail” which is composed of the particles located in quadruple δ . This is because of the very large change in Hamiltonian with an octupole, as discussed above. This phenomenon always corresponds with particles in the halo. The long “tail” is usually out of the boundary of the target, and particles in the “tail” become useless. More than that, the particles in the “tail” are difficult to transport to the target, and most of them are lost on the pipe during transfer. For the new magnet, there is no long “tail” because of the new type of magnet has a smaller field from 20 mm to

40 mm compared to the octupole. In these two plots, for particles within 20 mm, the distorted beam profiles have the same shape because of the same changes of Hamiltonian, as shown in Table 2. So, the two beams have the same uniform distributions in real space. The advantage of the new type of magnet is clear. The same uniform transverse profile beam as the octupole can be obtained without the “tail”, which means no particles in the “tail” will be lost in the later transfer, and almost all of the particles in the beam transformed to the target are within the boundaries of the target and are therefore useful.

4 Application

To test the new type of magnet, some simulations have been made with the CPHS lattice. Tracewin code is used in these simulations. The parameters of the beam are listed in Table 1, and the β function of the lattice is shown in Fig. 8. There are two octupoles located in the lattice, which is designed for uniform beam, and a nonlinear magnet is set in one of the locations. 10 000 macro particles were used in this simulation, including 1% particles in the halo, which had tenfold RMS emittance. As discussed, the beam is flat when it passes the nonlinear magnet. We consider the x direction only in these simulations. The octupole strength can be calculated with the theory of Yuri et al. [1]. The beam density function is Gaussian. According to Eq. (1), it is easy to calculate the required octupole. In this example, the required integrated strength of the octupole is $5701 \text{ T}\cdot\text{m}^{-2}$. It should be noted that the strength is calculated with all the odd-order components. Only using the octupole, the octupole strength should be smaller. Comparing the beam distributions on the target, the integrated strength of the octupole is set to $3702 \text{ T}\cdot\text{m}^{-2}$. Then the new magnet is adjusted to have the same strength in the middle region as the octupole, as shown in Fig. 4. The width of the middle region can be obtained from the size of the transverse profile at the nonlinear magnet position.

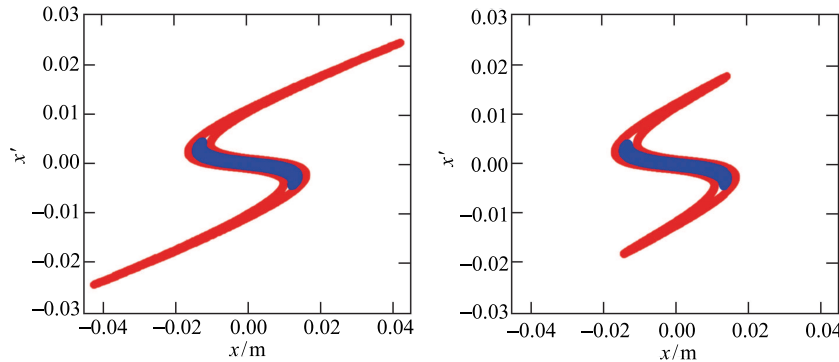

Fig. 7. (color online) The transverse beam profile on the target with the octupole (left) and with the new type of magnet (right). The blue shows the profile with 2δ and the red shows the profile with 4δ .

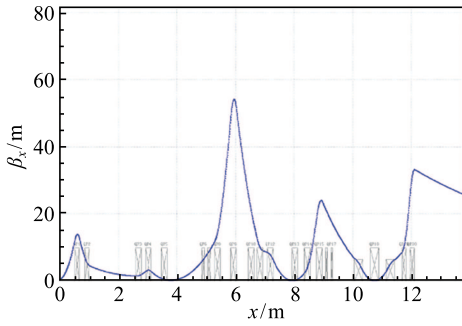

Fig. 8. β_x function of the CPHS lattice.

The simulation results are compared in several ways. The particle distributions in real space with an octupole and the new type of magnet are plotted in Figs. 9 and 10 to show the uniformity effect visually. Both of them have a uniform profile, but there are some particles located far from the core in Fig. 9. Obviously, these particles are part of the “tail” as discussed above, and most of them become useless because of the target limit. To compare the uniformity of the two distributions, the number of particles at different locations along x is plotted in Fig. 11.

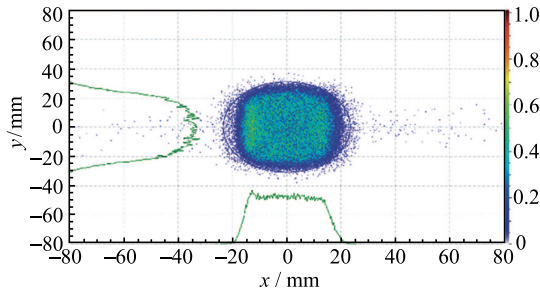

Fig. 9. (color online) Particle distribution on the target with an octupole.

The variance of the data can be used to present the uniformity of the two different distributions. The variances of the distributions with the octupole and new magnet are 2269 and 1758 respectively. Comparing the two variances, the two distributions can be supposed to have the same uniformity. As discussed, some particles in the “tail” will be lost. The numbers of lost macro particles are listed in Table 3. Comparing these data, there are 77 more particles lost with the octupole. This is another piece of evidence which shows the advantage of the new type of magnet.

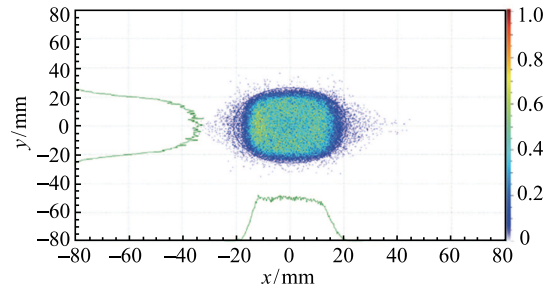

Fig. 10. (color online) Particle distribution on the target with the new type of magnet.

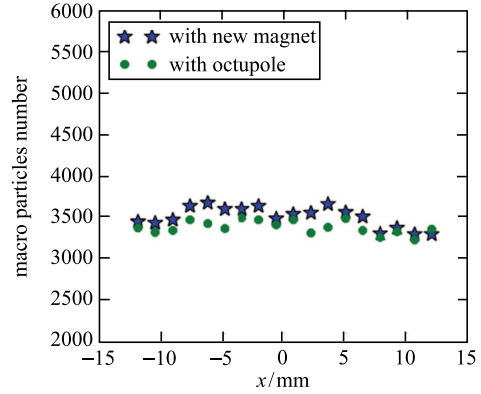

Fig. 11. Particle distribution along x -axis.

Table 3. Comparison of particle loss.

type	macro particles lost
none	5
octupole	91
new magnet	14

5 Conclusions

A new type of magnet is proposed and designed to replace the octupole in producing uniform transverse beam profiles. We have studied particle loss caused by the octupole, and compared it with the new type of magnet. The new type of magnet has two advantages compared with the octupole: it gives a uniform beam with less particle loss, and it has an adjustable octupole-like region to fit different beam transverse dimensions.

References

- 1 Y. Yuri, N. Miyawaki, T. Kamiya et al., *Physical Review Special Topics-Accelerators and Beams*, **10**(10): 104001 (2007)
- 2 Y. K. Batygin. *Nuclear Instruments and Methods in Physics Research Section B: Beam Interactions with Materials and Atoms*, **79**(1): 770–772 (1993)
- 3 F. Meot and T. Aniel, *Nuclear Instruments and Methods in Physics Research Section A: Accelerators, Spectrometers, Detectors and Associated Equipment*, **379**(2): 196–205 (1996)
- 4 P. F. Meads Jr, *A Nonlinear Lens System to Smooth the Intensity Distribution of a Gaussian Beam* (7053 Shirley Dr., Oakland, CA 94611, 1983)